



MAX9705B Evaluation Kit

General Description

The MAX9705B evaluation kit (EV kit) is a fully assembled and tested circuit board that uses the MAX9705B filterless Class D amplifier to drive a mono bridge-tied-load (BTL) speaker in portable audio applications. Designed to operate from a 2.5V to 5.5V DC power supply, the EV kit is capable of delivering 2.3W into a 4Ω load.

The EV kit accepts differential or single-ended input signals. The EV kit provides an option to select between different switching frequency modes of operation. The MAX9705B EV kit also evaluates the MAX9705A/MAX9705C/MAX9705D.

Ordering Information

PART	TEMP RANGE	IC PACKAGE
MAX9705BEVKIT	0°C to +70°C	10 TDFN-EP*

*EP = Exposed paddle.

Features

- ◆ Filterless Operation Passes FCC Radiated Emissions
- ◆ Evaluates the MAX9705A/B/C/D (with IC Replacement)
- ◆ 2.5V to 5.5V Single-Supply Operation
- ◆ 86% Efficiency
- ◆ Drives 2.3W into 4Ω Speaker at 1% THD+N
- ◆ Differential or Single-Ended Inputs
- ◆ Selectable Switching Frequency
- ◆ 0.1μA Shutdown Current
- ◆ Small 10-Pin TDFN Package
- ◆ Also Available in 10-Pin μMAX® and 12-Bump UCSP™ Packages
- ◆ Fully Assembled and Tested

μMAX is a registered trademark and UCSP is a trademark of Maxim Integrated Products, Inc.

Component List

DESIGNATION	QTY	DESCRIPTION
C1, C2	2	0.1μF ±10%, 25V X7R ceramic capacitors (0603) TDK C1608X7R1E104K
C5, C6	2	1μF ±10%, 6.3V X5R ceramic capacitors (0603) TDK C1608X5R0J105K
U1	1	MAX9705BETB (10-pin TDFN)
OPTIONAL COMPONENTS FOR CUSTOMER EVALUATION		
A1	0	Not installed, MAX9705BEUB (10-pin μMAX)
A2	0	Not installed, MAX9705BEBC (12-bump UCSP)
C3*	1	10μF ±20%, 6.3V X5R ceramic capacitor (0603) TDK C1608X5R0J106M
C4	1	100pF ±5%, 50V C0G ceramic capacitor (0603) TDK C1608C0G1H101J

DESIGNATION	QTY	DESCRIPTION
OPTIONAL COMPONENTS FOR CUSTOMER EVALUATION (continued)		
C7–C11	0	Not installed, capacitors (0603)
JU1	1	3-pin header
JU2	1	5-pin header
JU3	1	2-pin header
L1, L2	0	Not installed, inductors (TOKO D53LC Series)
OUT-, OUT+, FOUT-, FOUT+	0	Not installed, test points
R1	1	49.9Ω ±1% resistor (0603)
R2, R3	0	Not installed, resistors (0603)
—	3	Shunts
—	1	MAX9705B EV kit board

*System-level requirement.

Component Suppliers

SUPPLIER	PHONE	WEBSITE
TDK	847-803-6100	www.component.tdk.com
TOKO	847-297-0070	www.tokoam.com

Note: Indicate that you are using the MAX9705B when contacting these component suppliers.

MAX9705B Evaluation Kit

Quick Start

The MAX9705B EV kit is fully assembled and tested. Follow the steps listed below to verify board operation. **Do not turn on the power supply until all connections are completed.**

Recommended Equipment

- 2.5V to 5.5V, 1A power supply
- Audio source (i.e., CD player, cassette player)
- 8Ω speaker

Procedure

- 1) Install a shunt across pins 1 and 2 of jumper JU1 (EV kit ON).
- 2) Install a shunt across pins 1 and 2 of jumper JU2 (internal oscillator set to spread-spectrum mode).
- 3) Verify that no shunt is across jumper JU3 (differential input mode).
- 4) Connect the 8Ω speaker across the OUT+ and OUT- test points.
- 5) Connect the positive terminal of the power supply to the VDD pad and the power-supply ground terminal to the GND pad.
- 6) Connect the audio source across the INPUT+ and INPUT- pads.
- 7) Turn on the power supply.
- 8) Turn on the audio source.

Detailed Description

The MAX9705B EV kit features the MAX9705B filterless Class D amplifier IC, designed to drive a BTL mono speaker in portable audio applications. The EV kit operates from a DC power supply that can provide 2.5V to 5.5V and 1A of current. The EV kit accepts a differential or single-ended audio input. The audio input source is amplified to drive 2.3W into a 4Ω speaker.

The EV kit provides two sets of differential outputs. The device outputs (OUT+/-) can be connected directly to a speaker load, without any filtering, with up to 30cm of cable. However, a filter can be added to ease evaluation.

Output Filtering

The output (OUT+/-) can be connected directly to a speaker load without any filtering. Use the OUT+/- test points to connect the speakers directly to the EV kit outputs. This configuration is for a typical audio application.

The MAX9705B EV kit features PC board pads for filters that can be added to ease evaluation. Audio analyzers typically cannot accept pulse-width-modulated (PWM) signals at their inputs. The PWM output signal can be lowpass-filtered by installing components L1, L2, C7–C11, R2, and R3. The filtered outputs should then be monitored at the FOUT+/- test points. See Table 2 below for the suggested filtering components.

The MAX9705B is designed to pass FCC Class B RF emissions without additional filtering when using up to 30cm of cable to connect the speaker. Table 1 lists the cable length versus the required output components.

Table 1. Cable Length vs. Suggested Output Components

CABLE LENGTH X (cm)	LCR FILTER L1, L2, C7–C11, R2, R3
$X \leq 30$	—
$X > 30$	Required

Table 2. Suggested Filtering Components

COMPONENT	VALUE
C7, C8	0.033μF ±10%, 25V X7R ceramic capacitors (0603) TDK C1608X7R1E333K
C9	0.15μF ±10%, 25V X7R ceramic capacitor (0603) TDK C1608X7R1E154K
C10, C11	0.068μF ±10%, 25V X7R ceramic capacitors (0603) TDK C1608X7R1E683K
L1, L2	15μH ±20%, 1.4A inductors TOKO A915AY-150M
R2, R3	22Ω ±5% resistors (0603)

MAX9705B Evaluation Kit

Evaluates: MAX9705A/B/C/D

Jumper Selection

Shutdown Mode ($\overline{\text{SHDN}}$)

Jumper JU1 controls the shutdown pin ($\overline{\text{SHDN}}$) of the MAX9705B IC. See Table 3 for shunt positions.

Table 3. JU1 Jumper Selection ($\overline{\text{SHDN}}$)

SHUNT POSITION	$\overline{\text{SHDN}}$ PIN	EV KIT FUNCTION
1-2 (default)	High	Enabled
2-3	Low	Disabled
None (external logic controller connected to $\overline{\text{SHDN}}$ pad)	Connected to external controller	$\overline{\text{SHDN}}$ driven by external logic controller. Shutdown is active low.

Switching Frequency Mode (SYNC)

Jumper JU2 provides an option to select the switching frequency of the MAX9705B IC. See Table 4 for the various shunt positions.

Table 4. JU2 Jumper Selection (SYNC)

SHUNT POSITION	SYNC PIN	INTERNAL OSCILLATOR FREQUENCY
1-2 (default)	SYNC pin = high	Spread-Spectrum Mode. Set at a switching frequency $f_{\text{sw}} = 1.22\text{MHz} \pm 120\text{kHz}$
1-3	SYNC pin = floating	Set at $f_{\text{sw}} = 1.45\text{MHz}$
1-4	SYNC pin = external TTL-compatible clock input. External clock input connected to SYNC (TTL).	Synchronized to the incoming TTL-compatible clock frequency
1-5	$\text{SYNC} = \text{low}$	Set at $f_{\text{sw}} = 1.1\text{MHz}$

Input Mode

Jumper JU3 provides an option to select between a differential or single-ended input mode for the EV kit. See Table 5 for shunt positions.

Table 5. JU3 Jumper Selection (Input Mode)

SHUNT POSITION	EV KIT INPUT MODE
None (default)	Differential Input Mode
Installed (INPUT- pad connected to GND)	Single-Ended Input Mode

Evaluating the MAX9705A/MAX9705C/MAX9705D

The MAX9705B EV kit can evaluate the MAX9705A, MAX9705C, and MAX9705D. To evaluate a different IC, replace U1 with the desired part. Refer to the MAX9705 IC data sheet for additional information.

MAX9705B Evaluation Kit

Evaluates: MAX9705A/B/C/D

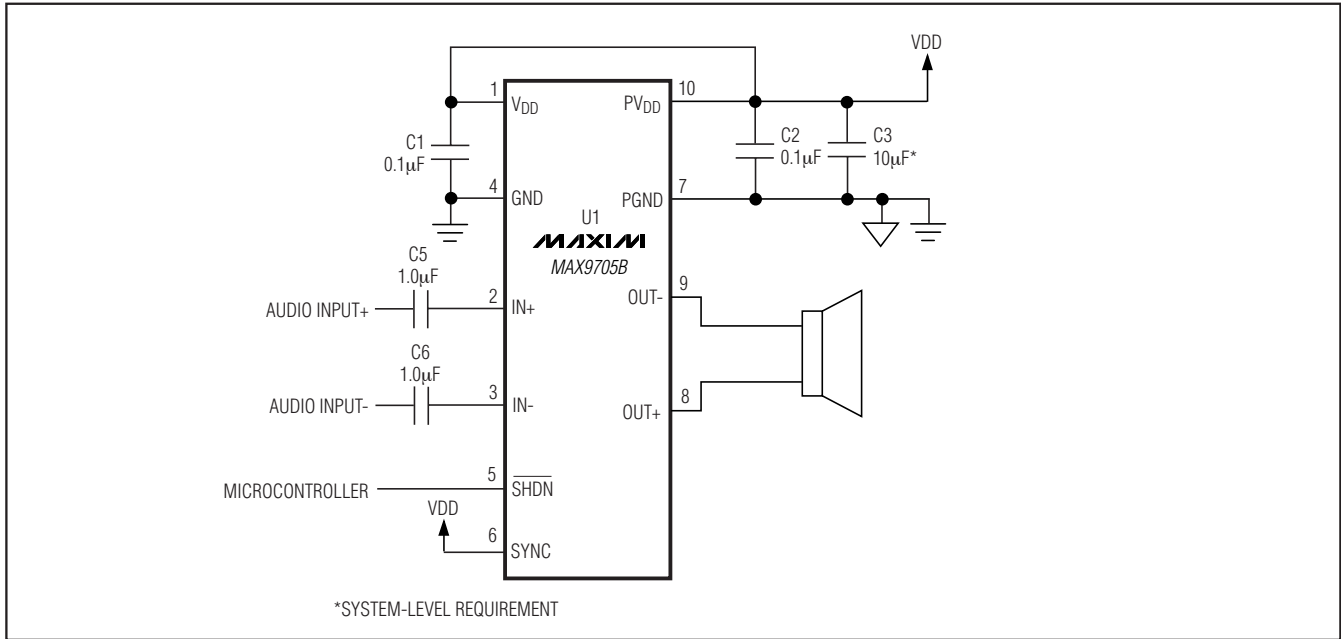

Figure 1. MAX9705B EV Kit Customer Design Schematic

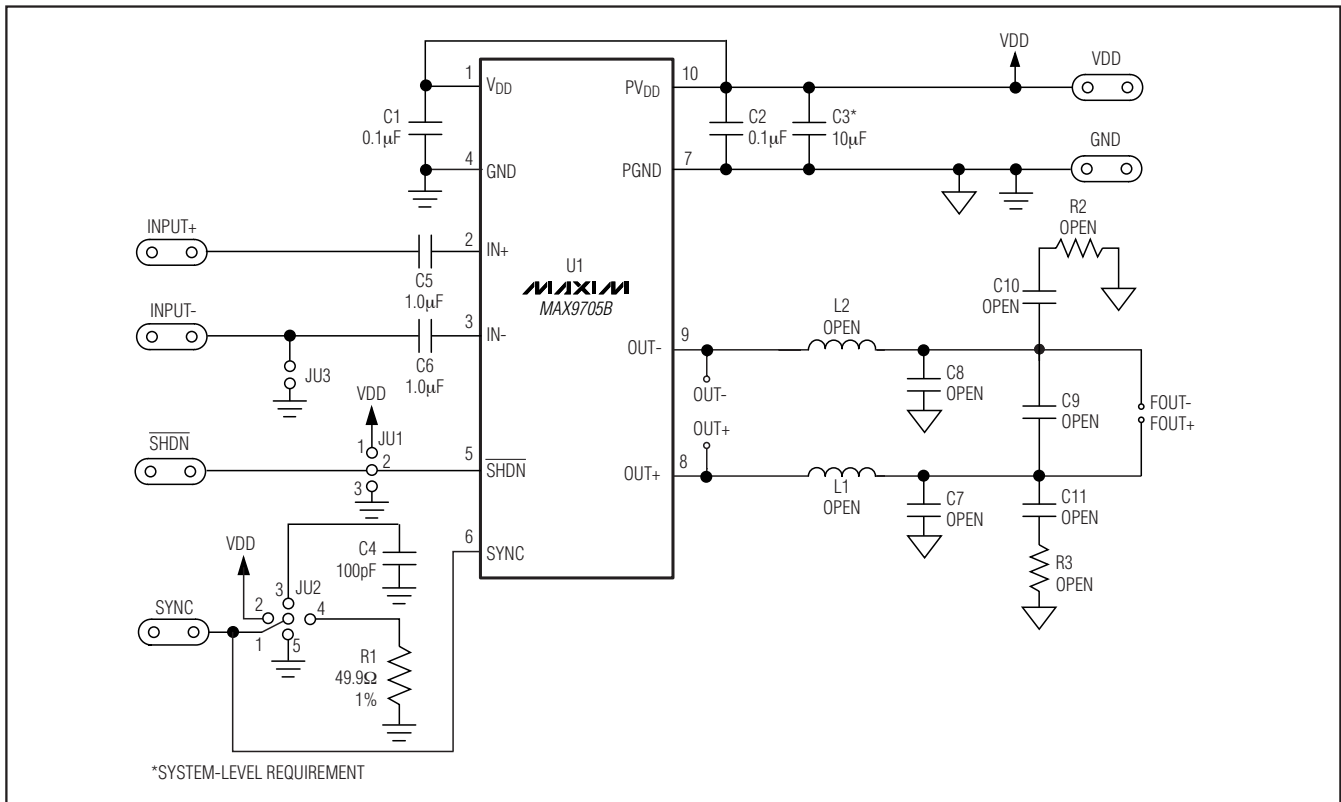

Figure 2. MAX9705B EV Kit Schematic

MAX9705B Evaluation Kit

Evaluates: MAX9705A/B/C/D

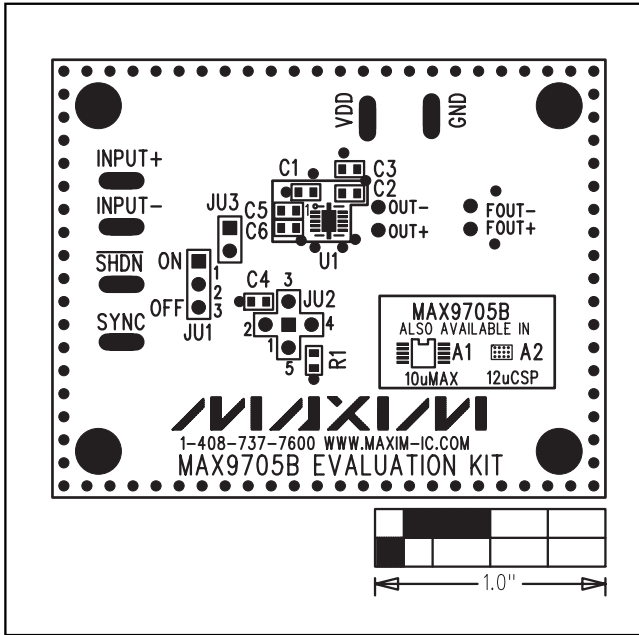

Figure 3. MAX9705B EV Kit Component Placement Guide—Component Side

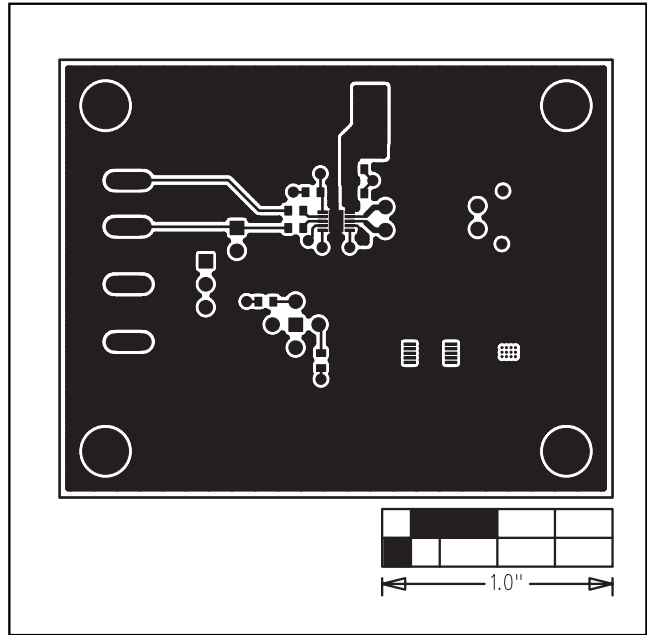

Figure 4. MAX9705B EV Kit PC Board Layout—Component Side

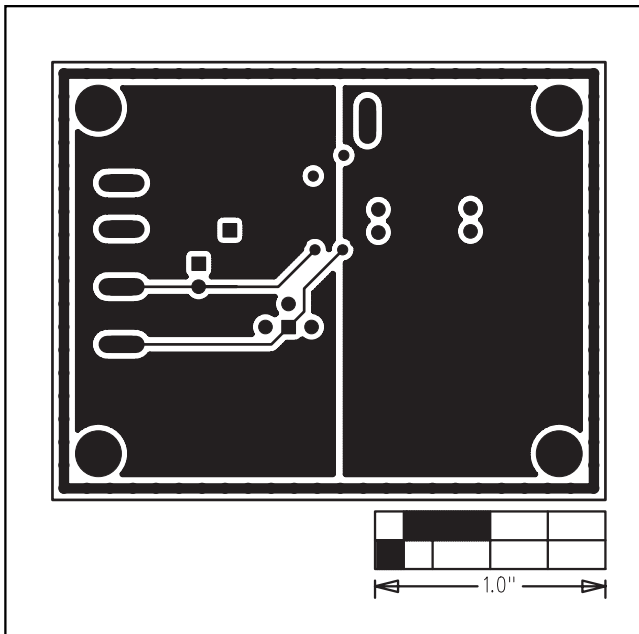

Figure 5. MAX9705B EV Kit PC Board Layout—GND Layer 2

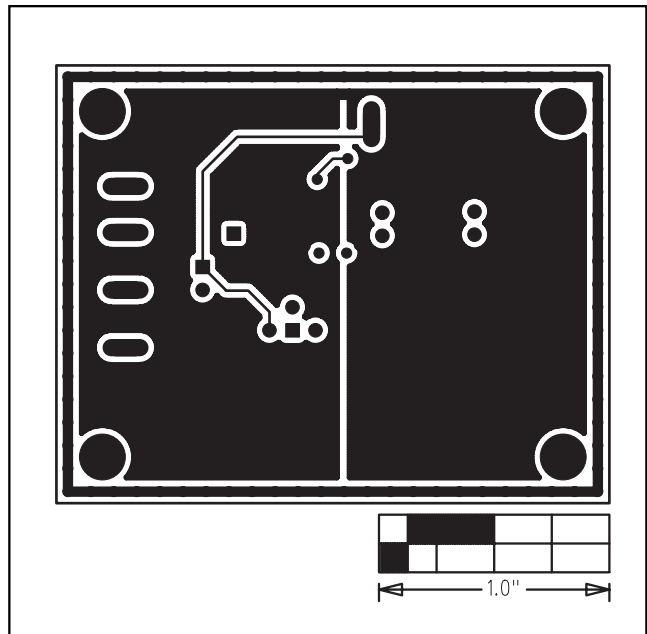

Figure 6. MAX9705B EV Kit PC Board Layout—GND Layer 3

MAX9705B Evaluation Kit

Evaluates: MAX9705A/B/C/D

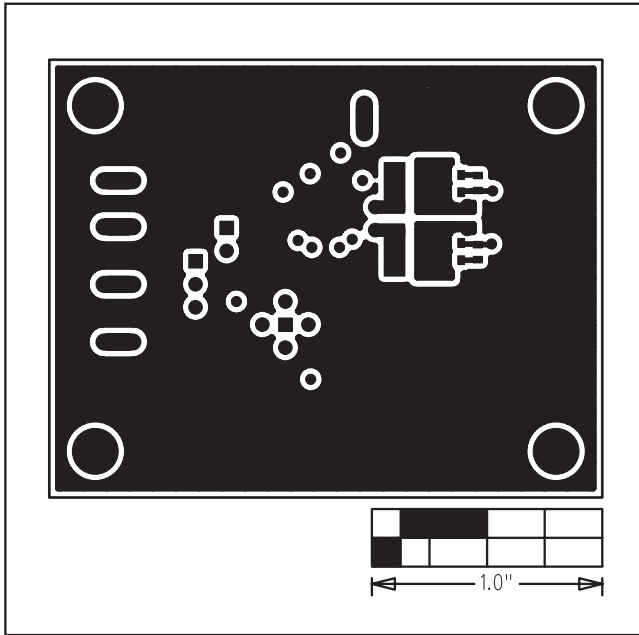

Figure 7. MAX9705B EV Kit PC Board Layout—Solder Side

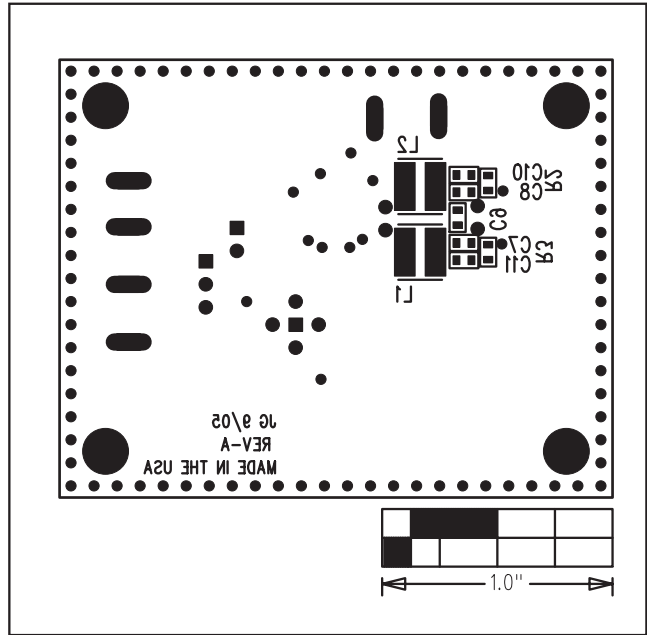

Figure 8. MAX9705B EV Kit Component Placement Guide—Solder Side

Maxim cannot assume responsibility for use of any circuitry other than circuitry entirely embodied in a Maxim product. No circuit patent licenses are implied. Maxim reserves the right to change the circuitry and specifications without notice at any time.

6 _____ **Maxim Integrated Products, 120 San Gabriel Drive, Sunnyvale, CA 94086 408-737-7600**